

5015

51x51x15MM

General Specifications

- ◆ Material..... Frame: Plastic (UL94V-0)
Impeller: Plastic (UL94V-0)
Lead Wire: UL1007AWG#26 or Equivalent (+) Red, (-) Black
- ◆ Expected Life..... Ball Bearing 70,000hrs (40°C)
Sleeve Bearing 30,000hrs (40°C)
- ◆ Temperature Range.... Operating temperature -10°C~70°C (Non-condensing)
Storage temperature -40°C~70°C (Non-condensing)
- ◆ Safety Standards..... UI, TUV, RoHS, CE
- ◆ DC Fan Specials..... RD, FG, PWM, IP56



Specifications

Model	#Bearing Type	Rated Voltage	Operating Voltage	Input Current	Input Power	Speed	Max Air Flow		Max Static Pressure		Noise	Weight
Part No.	B.S	VDC	VDC	Amp	Watt	RPM	CFM	m ³ /min	Inch-H ₂ O	Pa	dB-A	g
DB05015#05H	B.S	5	3.5~5.5	0.45	2.25	5500	3.49	0.10	0.35	87.97	38.0	30.0
DB05015#05M	B.S	5	3.5~5.5	0.35	1.75	5000	3.21	0.09	0.29	71.59	34.0	30.0
DB05015#05L	B.S	5	3.5~5.5	0.25	1.25	4500	2.86	0.08	0.24	60.21	27.0	30.0
DB05015#12H	B.S	12	7.0~13.8	0.18	2.16	5500	3.49	0.10	0.35	87.97	38.0	30.0
DB05015#12M	B.S	12	7.0~13.8	0.15	1.80	5000	3.21	0.09	0.29	71.59	34.0	30.0
DB05015#12L	B.S	12	7.0~13.8	0.12	1.44	4500	2.86	0.08	0.24	60.21	27.0	30.0
DB05015#24H	B.S	24	14.0~27.6	0.10	2.40	5500	3.49	0.10	0.35	87.97	38.0	30.0
DB05015#24M	B.S	24	14.0~27.6	0.08	1.92	5000	3.21	0.09	0.29	71.59	34.0	30.0
DB05015#24L	B.S	24	14.0~27.6	0.06	1.44	4500	2.86	0.08	0.24	60.21	27.0	30.0

Specifications are subject to change without notice. Please visit our website at <http://www.szhxht.com> for update information

Dimensions (Unit:mm)

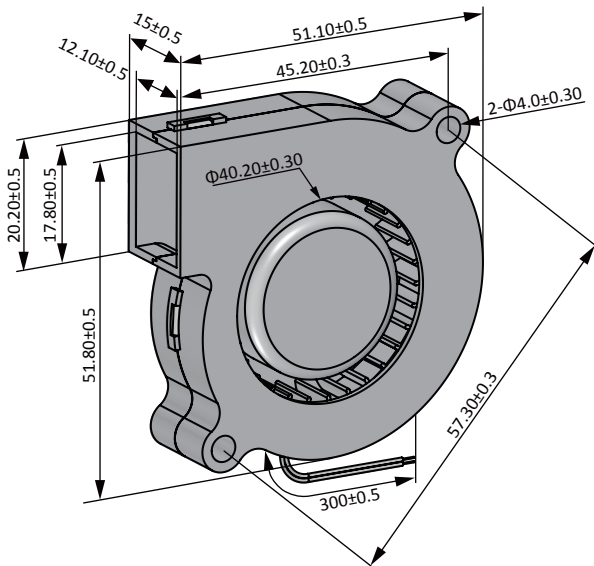

PQ Curve (At rated Voltage)

