

9225

92x92x25MM



General Specifications

- ◆ Material..... Frame: Plastic (UL94V-0)
Impeller: Plastic (UL94V-0)
Lead Wire: UL1007AWG#24 or Equivalent (+) Red, (-) Black
- ◆ Expected Life..... Ball Bearing 70,000hrs (40°C)
Sleeve Bearing 30,000hrs (40°C)
- ◆ Temperature Range.... Operating temperature -10°C~70°C (Non-condensing)
Storage temperature -40°C~70°C (Non-condensing)
- ◆ Safety Standards..... UL, TUV, RoHS, CE
- ◆ DC Fan Specials..... RD, FG, PWM, IP56

Specifications

Model	#Bearing Type	Rated Voltage	Operating Voltage	Input Current	Input Power	Speed	Max Air Flow	Max Static Pressure	Noise	Weight		
Part No.	B.S	VDC	VDC	Amp	Watt	RPM	CFM	m ³ /min	Inch-H ₂ O	Pa	dB-A	g
DA09225#12U	B.S	12	7.0~13.8	0.60	7.20	4000	63.73	1.80	0.22	55.80	47.0	78.0
DA09225#12H	B.S	12	7.0~13.8	0.50	6.00	3500	54.98	1.56	0.18	43.74	41.0	78.0
DA09225#12M	B.S	12	7.0~13.8	0.40	4.80	3000	46.23	1.31	0.13	31.68	37.0	78.0
DA09225#12L	B.S	12	7.0~13.8	0.30	3.60	2500	37.93	1.07	0.09	22.95	31.0	78.0
DA09225#12D	B.S	12	7.0~13.8	0.20	2.40	2000	30.96	0.88	0.06	16.18	25.0	78.0
DA09225#24U	B.S	24	14.0~27.6	0.50	12.00	4000	63.73	1.80	0.22	55.80	47.0	78.0
DA09225#24H	B.S	24	14.0~27.6	0.40	9.60	3500	54.98	1.56	0.18	43.74	41.0	78.0
DA09225#24M	B.S	24	14.0~27.6	0.30	7.20	3000	46.23	1.31	0.13	31.68	37.0	78.0
DA09225#24L	B.S	24	14.0~27.6	0.20	4.80	2500	37.93	1.07	0.09	22.95	31.0	78.0
DA09225#24D	B.S	24	14.0~27.6	0.15	3.60	2000	30.96	0.88	0.06	16.18	25.0	78.0
DA09225#48U	B.S	48	28.0~56.0	0.40	19.20	4000	63.73	1.80	0.22	55.80	47.0	78.0
DA09225#48H	B.S	48	28.0~56.0	0.25	12.00	3500	54.98	1.56	0.18	43.74	41.0	78.0
DA09225#48M	B.S	48	28.0~56.0	0.20	9.60	3000	46.23	1.31	0.13	31.68	37.0	78.0
DA09225#48L	B.S	48	28.0~56.0	0.15	7.20	2500	37.93	1.07	0.09	22.95	31.0	78.0

Specifications are subject to change without notice. Please visit our website at <http://www.szhxht.com> for update information

Dimensions (Unit:mm)

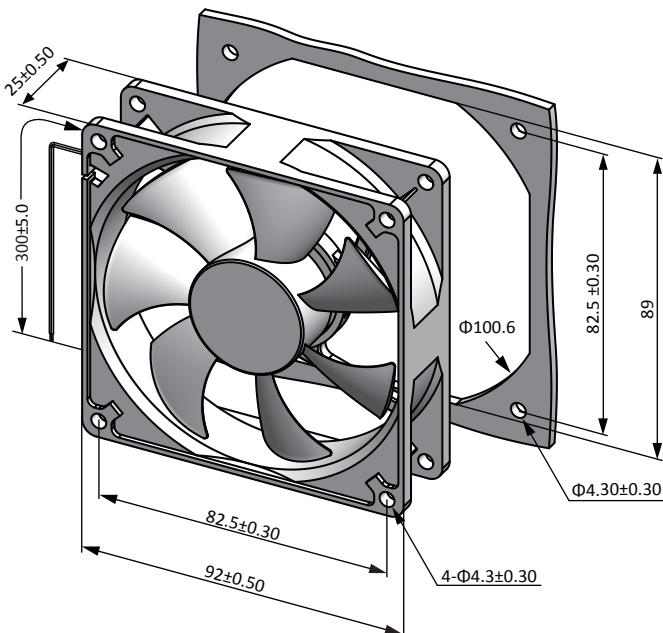

PQ Curve (At rated Voltage)

