

8020

80x80x20MM

General Specifications

- ◆ Material..... Frame: Plastic (UL94V-0)
Impeller: Plastic (UL94V-0)
Lead Wire: UL1007AWG#24 or Equivalent (+) Red, (-) Black
- ◆ Expected Life..... Ball Bearing 70,000hrs (40°C)
Sleeve Bearing 30,000hrs (40°C)
- ◆ Temperature Range.... Operating temperature -10°C~70°C (Non-condensing)
Storage temperature -40°C~70°C (Non-condensing)
- ◆ Safety Standards..... UI, TUV, RoHS, CE
- ◆ DC Fan Specials..... RD, FG, PWM, IP56



Specifications

Model	#Bearing Type	Rated Voltage	Operating Voltage	Input Current	Input Power	Speed	Max Air Flow		Max Static Pressure		Noise	Weight
Part No.	B.S	VDC	VDC	Amp	Watt	RPM	CFM	m ³ /min	Inch-H ₂ O	Pa	dB-A	g
DA08020#12U	B.S	12	7.0~13.8	0.35	4.20	3500	40.31	1.14	0.14	34.52	35.0	58.0
DA08020#12H	B.S	12	7.0~13.8	0.25	3.00	3000	35.09	0.99	0.11	26.67	31.0	58.0
DA08020#12M	B.S	12	7.0~13.8	0.18	2.16	2500	30.72	0.87	0.08	21.08	25.0	58.0
DA08020#12L	B.S	12	7.0~13.8	0.13	1.56	2000	25.44	0.72	0.06	15.10	22.0	58.0
DA08020#24U	B.S	24	14.0~27.6	0.18	4.32	3500	40.31	1.14	0.14	34.52	35.0	58.0
DA08020#24H	B.S	24	14.0~27.6	0.14	3.36	3000	35.09	0.99	0.11	26.67	31.0	58.0
DA08020#24M	B.S	24	14.0~27.6	0.10	2.40	2500	30.72	0.87	0.08	21.08	25.0	58.0
DA08020#24L	B.S	24	14.0~27.6	0.07	1.68	2000	25.44	0.72	0.06	15.10	22.0	58.0
DA08020#48U	B.S	48	28.0~56.0	0.08	3.84	3500	40.31	1.14	0.14	34.52	35.0	58.0
DA08020#48H	B.S	48	28.0~56.0	0.05	2.40	3000	35.09	0.99	0.11	26.67	31.0	58.0
DA08020#48M	B.S	48	28.0~56.0	0.04	1.92	2500	30.72	0.87	0.08	21.08	25.0	58.0
DA08020#48L	B.S	48	28.0~56.0	0.02	0.96	2000	25.44	0.72	0.06	15.10	22.0	58.0

Specifications are subject to change without notice. Please visit our website at <http://www.szhxht.com> for update information

Dimensions (Unit:mm)

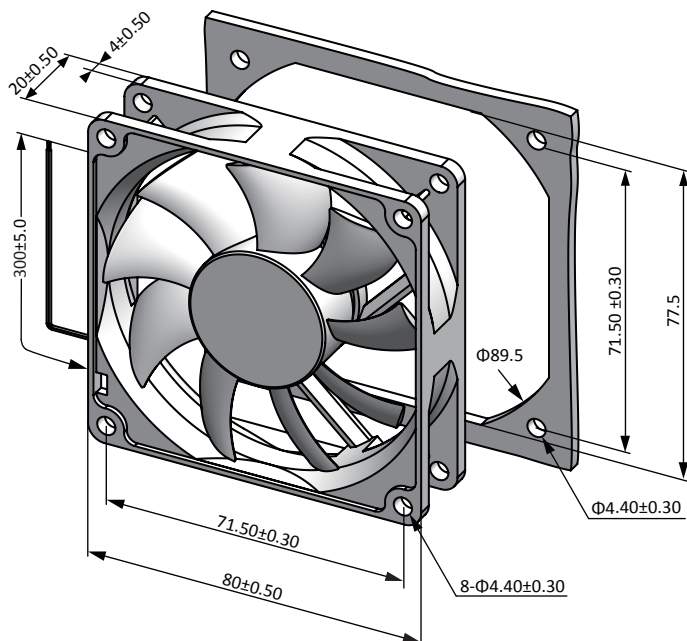

PQ Curve (At rated Voltage)

