

20060 200x200x60MM

General Specifications

- ◆ Material..... Frame: Aluminum Alloy ,Impeller: Plastic(UL94V-0)
Lead Wire: UL1015 20# black Terminal:2.5mm
- ◆ Motor..... Shaded Pole & Internal Rotor Motor
- ◆ Input Voltage..... 110V/220V (optional)
- ◆ Dielectric Strength..... 50/60Hz ,1500VAC 1Min(between input terminal and frame)
- ◆ Expected Life..... Ball Bearing 50000hrs (40°C)
- ◆ Temperature Range..... Operating temperature -10°C~+70°C(Non-condensing)
Storage temperature -40°C~+70°C(Non-condensing)



Dimensions(Unit:mm)

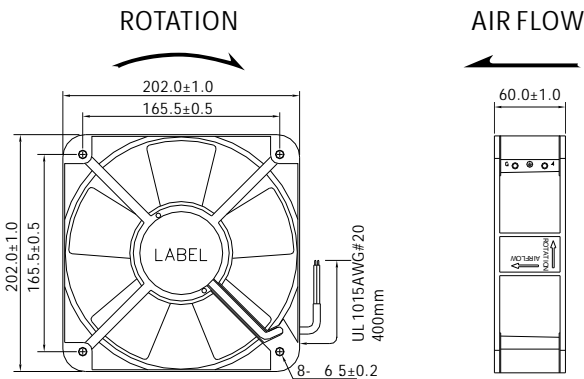

Mounting Panel Cutout (Unit:mm)

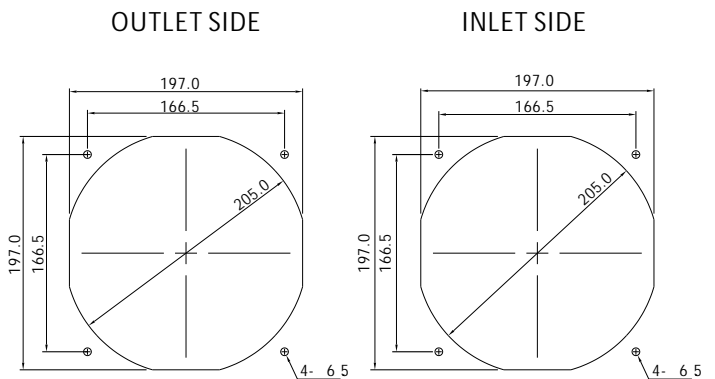

PQ Curve(At Rated Voltage)

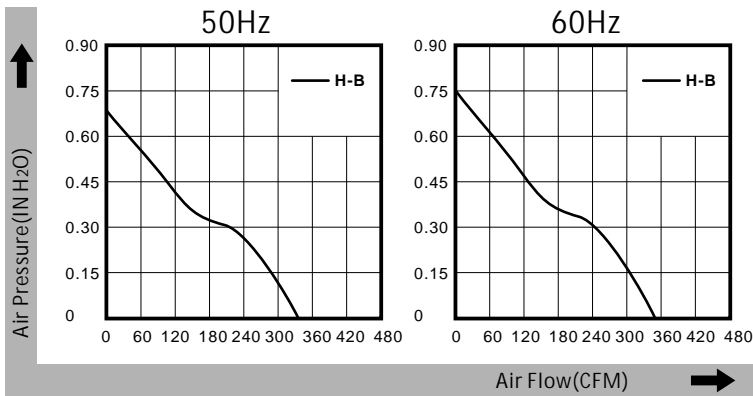

Safety Standards



Specifications

Model	Bearing Type	Rated Voltage	Freq	Rated Current	Input Power	Speed	Max Air Flow	Max Static Pressure	Noise	Weight
Part No.	B	VAC	Hz	Amp	Watt	RPM	CFM	Inch-H ₂ O	dB-A	g
AA20060B11HL(T)	Dual Ball	100~120	50/60	0.76/0.65	77/55	2300/2500	335/350	0.67/0.75	63/68	1600
AA20060B22HL(T)	Dual Ball	200~240	50/60	0.38/0.32	77/55	2300/2500	335/350	0.67/0.75	63/68	1600

Specifications are subject to change without notice. Please Visit our website at <http://www.szhxht.com> for update information.