

12025 120x120x25MM

General Specifications

- ◆ Material..... Frame: Aluminum Alloy ,Impeller: Plastic(UL94V-0)
Lead Wire: UL1007 22# black Terminal:2.5mm
- ◆ Motor..... Shaded Pole & Internal Rotor Motor
- ◆ Input Voltage..... 110V/220V (optional)
- ◆ Dielectric Strength..... 50/60Hz ,1500VAC 1Min(between input terminal and frame)
- ◆ Expected Life..... Ball Bearing 50000hrs, Sleeve Bearing 30000hrs(40°C)
- ◆ Temperature Range..... Operating temperature -10°C~+70°C(Non-condensing)
Storage temperature -40°C~+70°C(Non-condensing)



Dimensions(Unit:mm)

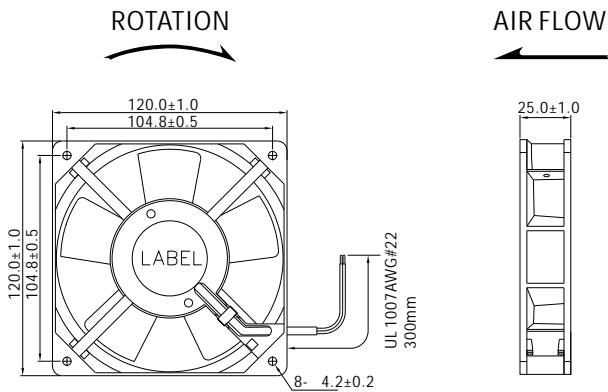

Mounting Panel Cutout (Unit:mm)

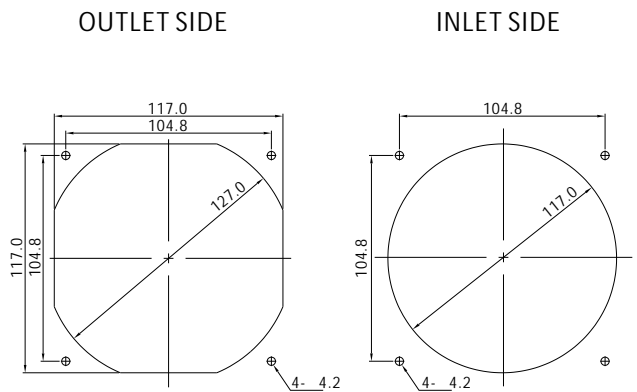

PQ Curve(At Rated Voltage)

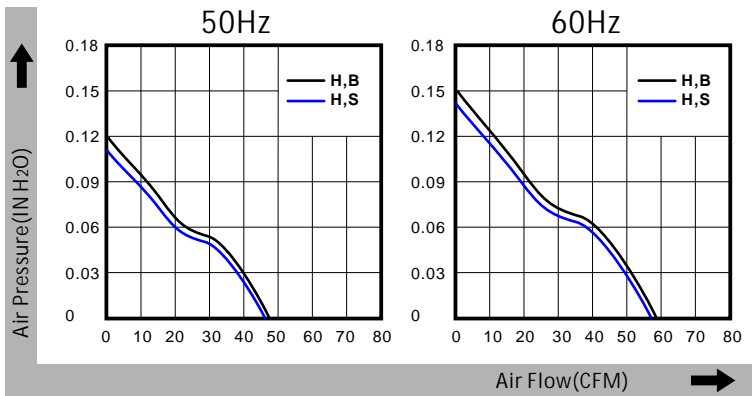

Safety Standards



Specifications

Model	Bearing Type	Rated Voltage	Freq	Rated Current	Input Power	Speed	Max Air Flow	Max Static Pressure	Noise	Weight
Part No.	B/S	VAC	Hz	Amp	Watt	RPM	CFM	Inch-H ₂ O	dB-A	g
AA12025S11HL(T)	Sleeve	100~120	50/60	0.14/0.12	18/16	2000/2400	46/56	0.11/0.14	34/38	380
AA12025S22HL(T)	Sleeve	200~240	50/60	0.08/0.07	18/16	2000/2400	46/56	0.11/0.14	34/38	380
AA12025B11HL(T)	Dual Ball	100~120	50/60	0.14/0.12	18/16	2100/2500	48/59	0.12/0.15	35/39	380
AA12025B22HL(T)	Dual Ball	200~240	50/60	0.08/0.07	18/16	2100/2500	48/59	0.12/0.15	35/39	380

Specifications are subject to change without notice. Please Visit our website at <http://www.szhxht.com> for update information.